

HARMONY

KITCHEN ACCESSORIES

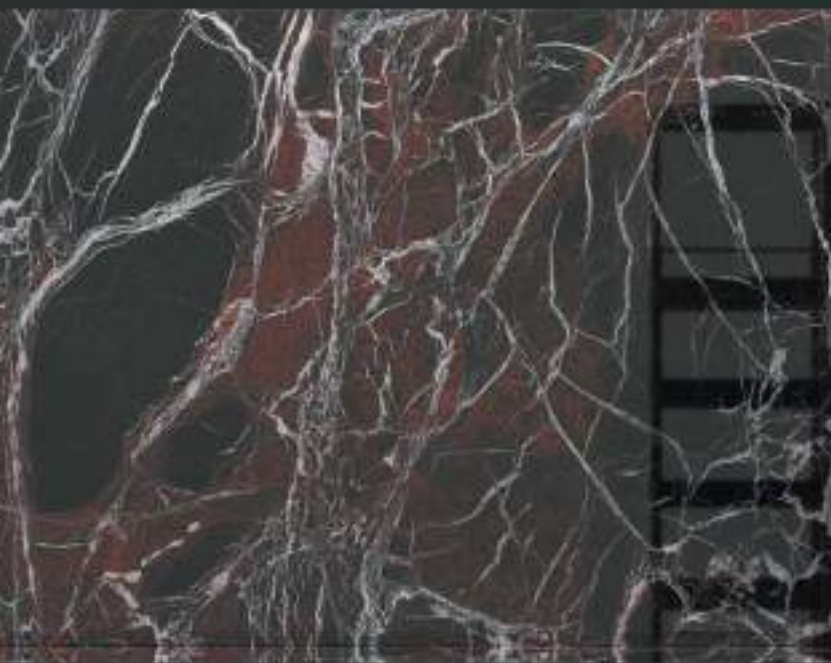

emuca 
where creation begins

HARMONY

KITCHEN ACCESSORIES



INDICE

INDEX

- 10 Eleganza funzionale
Functional elegance
- 26 Design sofisticato
Sophisticated design
- 38 Informazioni tecniche
Technical information

HARMONY

KITCHEN ACCESSORIES





L'ARMONIA TRA ELEGANZA, TECNOLOGIA E FUNZIONALITÀ

Harmony è l'anima della cucina, è la gamma di accessori dove ogni movimento è fluido e preciso, dove la robustezza si veste di eleganza e dove il grigio antracite e il legno creano un'atmosfera calda e sofisticata per sfruttare ogni angolo senza rinunciare al design.

THE HARMONY BETWEEN ELEGANCE, TECHNOLOGY AND FUNCTIONALITY

Harmony is the soul of the kitchen, a range of accessories where every movement is smooth and precise, where robustness is dressed in elegance, and where anthracite grey and wood create a warm and sophisticated atmosphere to make the most of every corner without compromising on design.





ELEGANZA
FUNZIONALE
FUNCTIONAL ELEGANCE







Design che si nasconde. Funzionalità che sorprende

Design that hides itself. Functionality that surprises

Progettata per scomparire alla vista e brillare ad ogni utilizzo, la gamma Harmony si integra completamente all'interno del mobile, offrendo soluzioni eleganti, silenziose e resistenti. Ogni accessorio è facile da installare, regolabile con precisione e in grado di sostenere carichi elevati senza perdere nulla della sua fiudità. Tutto è nascosto, tutto è in ordine, tutto è in perfetta armonia.

Designed to disappear from view and shine with every use, the Harmony range blends seamlessly into the interior of the cabinet, offering elegant, silent and durable solutions. Each accessory is easy to install, precisely adjustable and can support heavy loads without losing any of its smoothness. Everything is hidden, everything is tidy, everything is in perfect harmony.



Progettati per trasformare l'inaccessibile in essenziale

Gli angolari sono la soluzione perfetta per sfruttare ogni spazio, con ripiani scorrevoli che offrono ordine, capienza e bellezza nei luoghi più inaspettati. Eleganti e funzionali, sono pensati perchè nulla sia fuori dalla tua portata, perché in una cucina intelligente anche l'ultimo angolo ha una sua funzione.

Designed to transform the inaccessible into the essential

Corner units are the perfect solution for making the most of every space, with sliding trays that offer organisation, storage and beauty in the most unexpected places. Elegant and functional, they are designed so that nothing is out of reach, because in a smart kitchen, even the smallest corner has a purpose.





Comodo accesso, spazi aggiuntivi da sfruttare

Poiché non tutte le cucine sono uguali, i carrelli Harmony sono disponibili in diverse larghezze e altezze, che consentono di configurare l'interno del mobile in modo organizzato e sempre accessibile. E la cosa migliore: si chiudono dolcemente, senza urti né sbattimenti.

Convenient access, superior storage

Because not all kitchens are the same, Harmony units are available in different widths and heights, allowing you to organise the interior of the cabinet in an organised and accessible way. And best of all, they close softly, without banging or slamming.





Elegante fuori, sorprendente dentro

La colonna dispensa Harmony ridefinisce lo spazio verticale con un sistema di estrazione che avvicina tutti i ripiani in modo fluido, silenzioso e preciso. Tutto rimane organizzato, accessibile e perfettamente integrato all'interno del mobile. Una soluzione elegante e versatile, progettata per sfruttare al massimo ogni centimetro della tua cucina.

Elegant on the outside, surprising on the inside

The Harmony pantry column redefines vertical storage with a pull-out system that brings all the trays out smoothly, silently and precisely. Everything stays organised, accessible and perfectly integrated inside the unit. An elegant and versatile solution, designed to make the most of every inch of your kitchen.



Trasformiamo ogni angolo in design e funzionalità

Questi portabottiglie trasformano gli spazi più stretti in brillanti soluzioni di utilizzo. La loro struttura in acciaio e il fondo in legno valorizzano anche gli angoli più discreti. Perché in una cucina ben progettata, ogni centimetro è prezioso.

How to transform a gap into design and functionality

These bottle racks turn even the smallest spaces into brilliant storage solutions. Their steel structure and wooden base enhance even the most inconspicuous corners. Because in a well-designed kitchen, every inch counts.



La gamma che veste le cucine più esigenti

Progettata per chi cerca il meglio anche all'interno, la gamma Harmony combina funzionalità avanzata e un'estetica impeccabile. Le finiture in grigio antracite e legno si integrano perfettamente con i design più contemporanei e sofisticati delle cucine, valorizzando ogni mobile dall'interno. Scorrono dolcemente e offrono un'organizzazione precisa e silenziosa.

The range that dresses the most demanding kitchens

Designed for those who seek the best inside and out, the Harmony range combines advanced functionality with impeccable aesthetics. Its anthracite grey and wood finishes blend seamlessly with the most contemporary and sophisticated kitchen designs, elevating each piece of furniture from the inside out. They slide smoothly and offer precise, silent organisation.



Eleganza funzionale / Funcional elegance

Emuca | Harmony

DESIGN SOFISTICATO

SOPHISTICATED DESIGN







Estrai. Gira.
E accedi senza
limiti.

Questa colonna porta lo spazio di utilizzo a un altro livello. Prima scorre delicatamente, poi ruota per offrirti un accesso totale. Una soluzione intelligente che combina la massima capacità, la fluidità dei movimenti e il design per cucine di alta gamma. Perché non si tratta solo di riporre, ma di godersi ogni movimento.

Extract. Rotate.
And access
without limits.

This column takes storage to another level. First it slides smoothly, then it rotates to give you full access. A smart solution that combines maximum capacity, smooth movement and design for high-end kitchens. Because it's not just about storage, it's about enjoying every movement.





Per ogni angolo, una soluzione. Per ogni cosa, il suo posto.

Questa gamma di accessori nasce per dare un senso a ogni spazio della cucina e combinare ordine, eleganza e funzionalità. Sono sistemi che scorrono dolcemente, si installano con facilità e offrono un'organizzazione precisa di ogni oggetto. Perché nelle cucine di alta gamma, anche gli interni parlano di stile. E con Harmony, dicono tutto.

A solution for every corner. A place for everything

This range of accessories has been created to give meaning to every space in the kitchen and combine order, elegance and functionality. These systems slide smoothly, are easy to install and offer precise organisation for every item. Because in high-end kitchens, the interior also speaks of style. And with Harmony, it says it all.







L'arte di conservare con stile, anche il pane

Questo carrello include una borsa in tessuto lavabile che mantiene il pane ben conservato ed evita che le briciole cadano all'interno del mobile. In questo modo, tutto rimane pulito, ordinato e sempre a portata di mano. La sua struttura, realizzata in acciaio resistente con finitura grigio antracite e fondo in legno, offre un design curato e durevole. Inoltre, scorre in modo silenzioso e fluido, con una chiusura ammortizzata che garantisce comfort ed eleganza ad ogni utilizzo.

The art of stylish storage, even for bread

This unit includes a washable fabric bag that keeps bread safely stored and prevents crumbs from falling inside the unit. This way, everything stays clean, tidy and always within reach. Its structure, made of sturdy steel with an anthracite grey finish and wooden base, offers a sleek and durable design. It also glides silently and smoothly, with a soft-close mechanism that provides comfort and elegance with every use.



La rotazione perfetta per sfruttare ogni angolo

Sono progettate per trasformare gli angoli più complessi della cucina in spazi utili, accessibili e ricchi di funzionalità. Il loro movimento è fluido, silenzioso e preciso, pensato per garantire che tutto scorra senza sforzo. Una soluzione intelligente ed elegante che eleva l'interno del mobile al livello del miglior design.

The perfect turn to make the most of every last corner

They are designed to turn the most complex corners of the kitchen into useful, accessible spaces full of purpose. Their movement is smooth, silent and precise, designed so that everything flows effortlessly. A smart and elegant solution that elevates the interior of the cabinet to the height of the best design.



INFORMAZIONI TECNICHE

TECHNICAL INFORMATION

Portabottiglie laterale estraibile Harmony con chiusura soft
Harmony pull out bottle rack with soft close

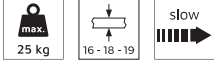

M	H	X	Y	n° cestini/ n° trays	Finitura/Finishing	Imballaggio/ Packaging	Cod.
150	700	96	500	2	Grigio antracite/Anthracite grey	1 UN/Unit	8381935
200	700	146	500	2	Grigio antracite/Anthracite grey	1 UN/Unit	8382135
150	800	96	708	3	Grigio antracite/Anthracite grey	1 UN/Unit	8382035
200	800	146	708	3	Grigio antracite/Anthracite grey	1 UN/Unit	8382235

Acciaio e Legno/Steel and Wood

M = 150
H = 700

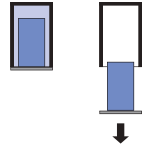
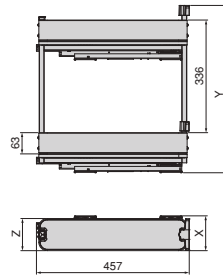

M = 150
H = 800

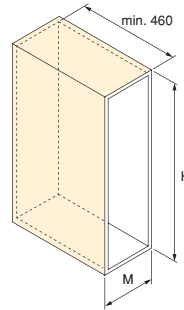
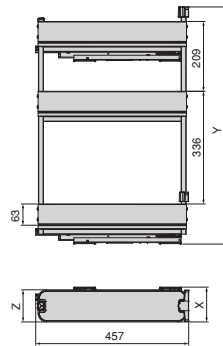

Guide nascoste con chiusura ammortizzata e estrazione totale, con fissaggio sul lato sinistro del modulo.
 Concealed runners with soft-close and full extension, fixed on the left side of the module.

Base con lamiera melaminica.
 Base with melamine sheet.

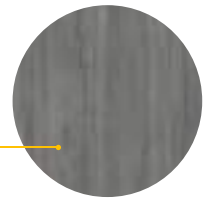

Regolazione in 5 dimensioni della porta.
 5-dimensional door adjustment.

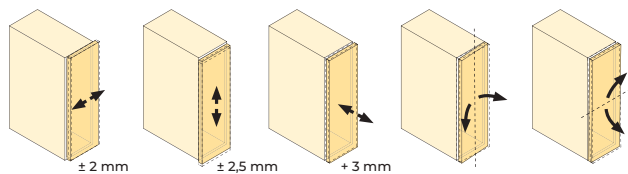

Carrello estraibile Harmony con chiusura soft Harmony pull-out trolley with soft close

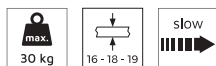

M	H	X	Y	n° cestini/ n° trays	Finitura/Finishing	Imballaggio/ Packaging	Cod.
300	700	262	500	2	Grigio antracite/Anthracite grey	1 UN/Unit	8382335
400	700	362	500	2	Grigio antracite/Anthracite grey	1 UN/Unit	8382535
300	800	262	705	3	Grigio antracite/Anthracite grey	1 UN/Unit	8382435
400	800	362	705	3	Grigio antracite/Anthracite grey	1 UN/Unit	8382635

Acciaio e Legno/Steel and Wood

M = 300
H = 700

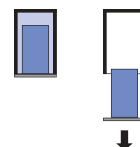
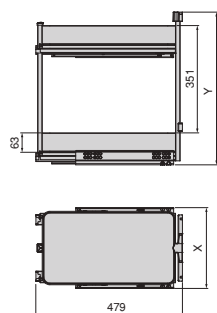

M = 300
H = 800

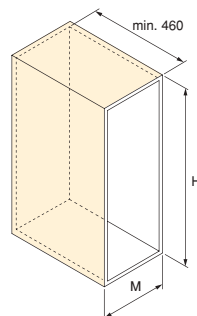
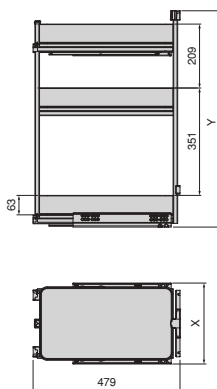

Guide nascoste con chiusura ammortizzata e estrazione totale, con fissaggio su entrambi i lati del modulo, ma a diverse altezze, per una maggiore stabilità.

Concealed runners with soft-close and full extension, fixed on both sides of the module, but at different heights, for greater stability.

Base con lamiera melaminica.
Base with melamine sheet.

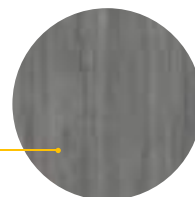

Regolazione in 5 dimensioni della porta.
5-dimensional door adjustment.

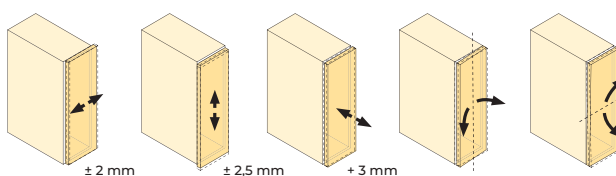

Carrello estraibile con cestelli e accessori Harmony con chiusura soft
Harmony pull-out rack with baskets and accessories with soft closing

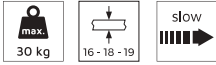

M	H	X	Y	Finitura/Finishing	Imballaggio/ Packaging	Cod.
300	700	262-268	543	Grigio antracite/Anthracite grey	1 UN/Unit	8382735
400	700	362-368	543	Grigio antracite/Anthracite grey	1 UN/Unit	8382835

Acciaio e Legno/Steel and Wood

M = 300
H = 700

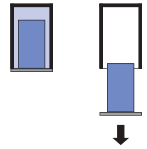
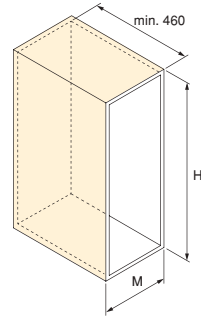
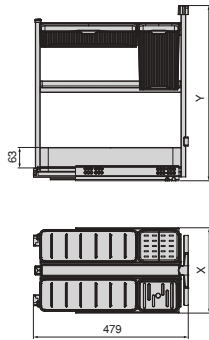

Guide nascoste con chiusura soft e estrazione totale, con fissaggio inferiore su entrambi i lati del modulo.
 Concealed soft-close runners with full extension, with bottom fixing on both sides of the module.

M = 400
H = 700

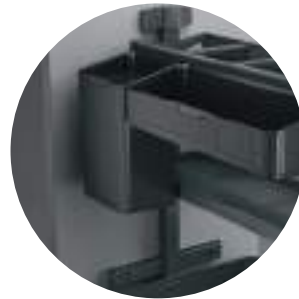
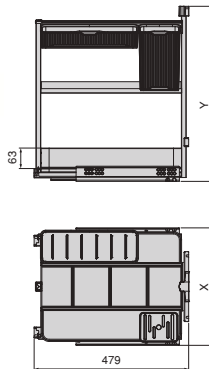

Base con lamiera melaminica.
Base with melamine sheet.

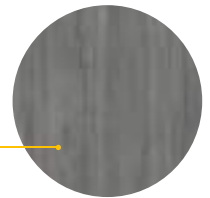

Regolazione in 5 dimensioni della porta.
5-dimensional door adjustment.

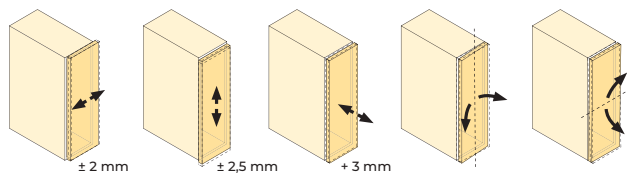

Carrello estraibile con cestelli e portapane Harmony con chiusura soft Harmony pull-out rack with baskets and bread basket with soft closing

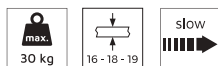

M	H	X	Y	Finitura/Finishing	Imballaggio/ Packaging	Cod.
300	700	262	500	Grigio antracite/Anthracite grey	1 UN/Unit	8382935

Acciaio e Legno/Steel and Wood

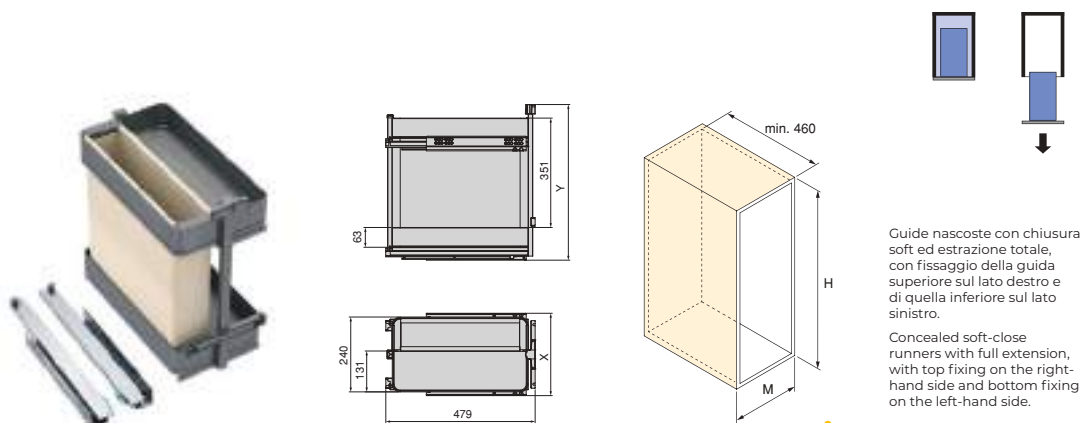

Borsa in tessuto facilmente estraibile per la pulizia.
Easy-removal fabric bag for cleaning.



Base con lamiera melaminica.
Base with melamine sheet.

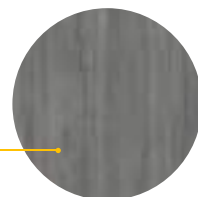

Regolazione in 5 dimensioni della porta.
5-dimensional door adjustment.

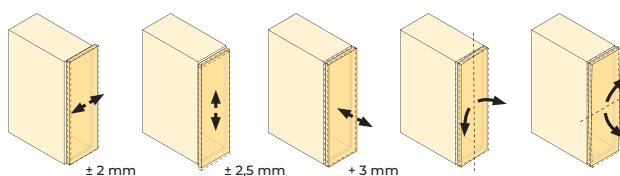

Coppia di cestelli girevoli Harmony semicircolare
Harmony 1/2 circle rotating trays



M	Finitura/Finishing	Imballaggio/Packaging	Cod.
800	Grigio antracite/Anthracite grey	1 UN/Unit	8383235

Acciaio e Legno/Steel and Wood

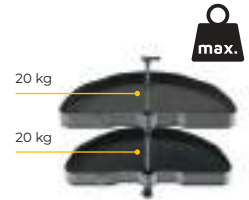
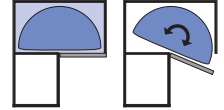
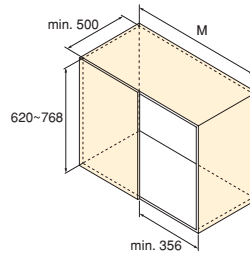

Base con lamiera melaminica.
 Base with melamine sheet.

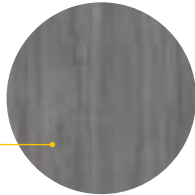

Regolazione dell'altezza compatibile con
 moduli fino a 800 mm.
 Height adjustment compatible with
 modules up to 800 mm.

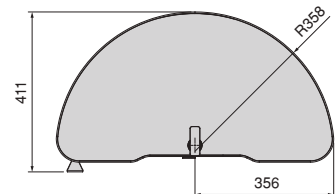
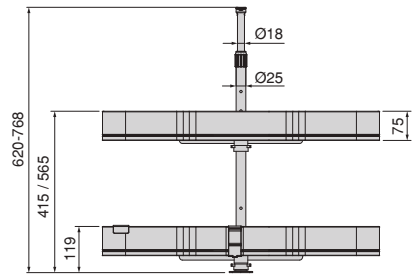

Coppia di cestelli girevole Harmony 3/4 Harmony 3/4 circle rotating trays



M	Finitura/Finishing	Imballaggio/Packaging	Cod.
800	Grigio antracite/Anthracite grey	1 UN/Unit	8383335

Acciaio e Legno/Steel and Wood

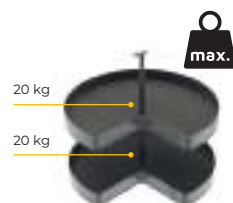
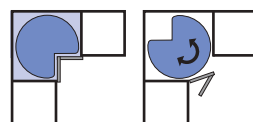
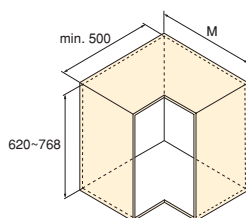

Base con lamiera melaminica.
Base with melamine sheet.

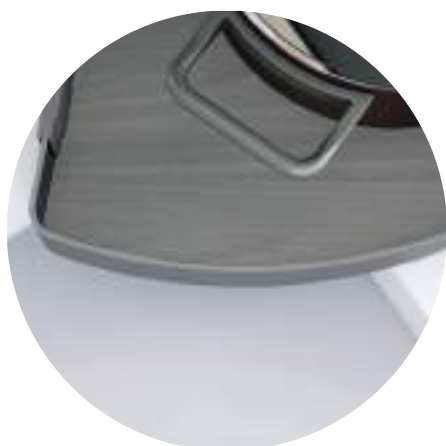
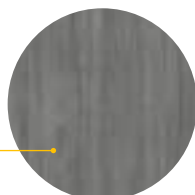

Regolazione dell'altezza compatibile con
moduli fino a 800 mm.
Height adjustment compatible with
modules up to 800 mm.

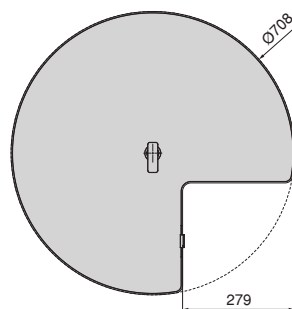
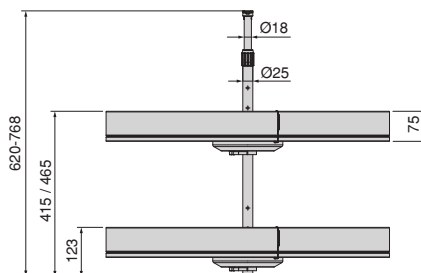

Sistema estraibile angolare Harmony per mobile da cucina
Harmony articulated corner for kitchen furniture

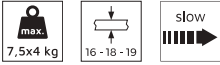

Lato/Hand	Finitura/Finishing	Imballaggio/Packaging	Cod.
Destra/Right Sinistra/Left	Grigio antracite/Anthracite grey 	1 UN/Unit	8383435

Acciaio e Legno/Steel and Wood

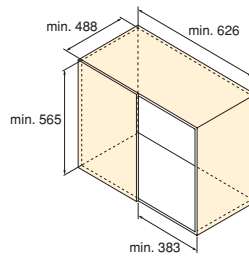

Destra/Right

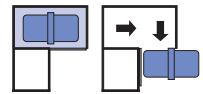

Sinistra/Left

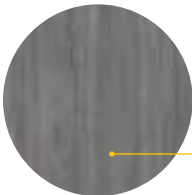
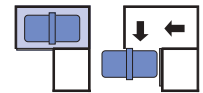

Base con lamiera melaminica.
Base with melamine sheet.

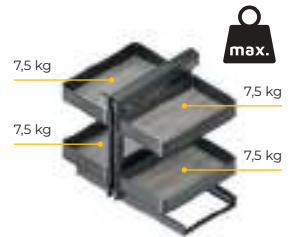

Consente il montaggio sia con apertura a sinistra che a destra.
Allows for installation with either left- or right-hand opening.

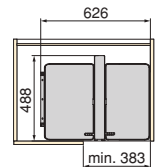
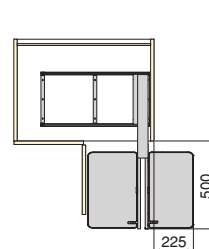
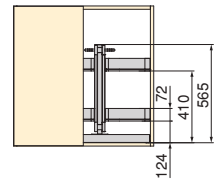

Destra/Right

Sistema estraibile angolare Harmony per mobili da cucina Harmony pull out corner module for kitchen furnitures



Lato/Hand	Finitura/Finishing	Imballaggio/Packaging	Cod.
Destra/Right	Grigio antracite/Anthracite grey	1 UN/Unit	8383635
Sinistra/Left	Grigio antracite/Anthracite grey	1 UN/Unit	8383535

Acciaio e Legno/Steel and Wood

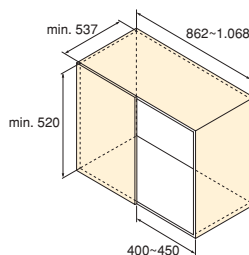

Destra/Right

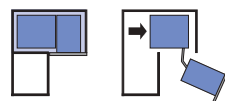

Sinistra/Left

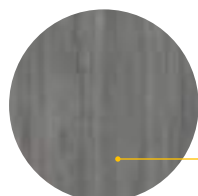
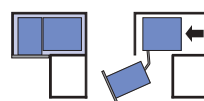

Base con lamiera melaminica.
Base with melamine sheet.



Regolazione della porta in 3 dimensioni: +6 mm in verticale, ±4 mm in orizzontale, ±3,5 mm in profondità.

3-dimensional door adjustment: +6 mm vertical, ±4 mm horizontal, ±3.5 mm depth.

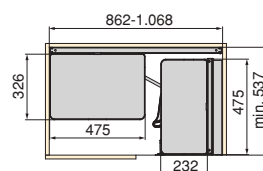
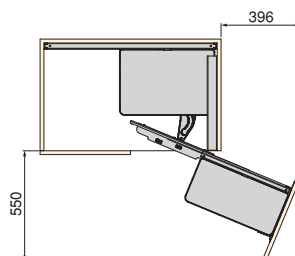
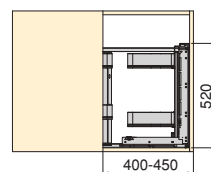

Destra/Right

Angolare Harmony per mobili da cucina
Harmony corner pull out for furniture

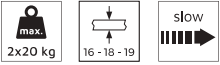

Lato/Hand	Finitura/Finishing	Imballaggio/Packaging	Cod.
Destra/Right	Grigio antracite/Anthracite grey	1 UN/Unit	8383135
Sinistra/Left	Grigio antracite/Anthracite grey	1 UN/Unit	8383035

Acciaio e Legno/Steel and Wood

Destra/Right

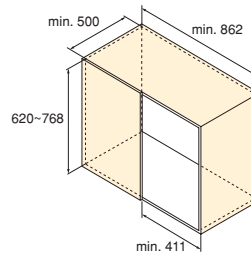

Destra/Right

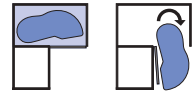

Sinistra/Left

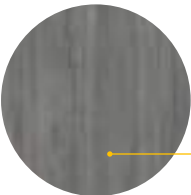
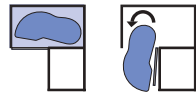

Base con lamiera melaminica.
 Base with melamine sheet.

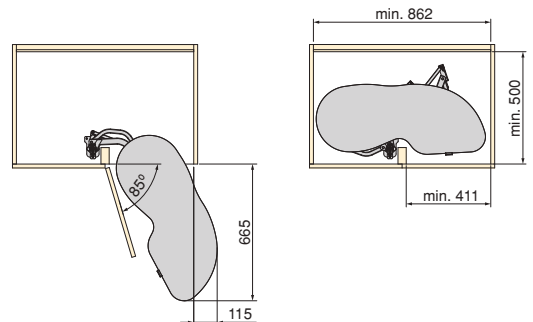
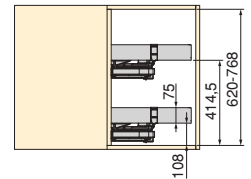
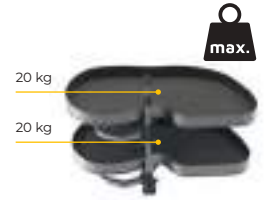

Destra/Right



Colonna dispensa estraibile Harmony per porta con cerniere per mobili da cucina
Harmony pull out larder unit with hinges for kitchen furniture



M	H	X	Y	n° cestini/ n° trays	Finitura/Finishing	Imballaggio/ Packaging	Cod.
450	min. 1.480	403	1.430	10	Grigio antracite/Anthracite grey	1 UN/Unit	8383935
450	min. 1.780	403	1.780	10	Grigio antracite/Anthracite grey	1 UN/Unit	8384035
600	min. 1.480	553	1.430	12	Grigio antracite/Anthracite grey	1 UN/Unit	8384135
600	min. 1.780	553	1.780	12	Grigio antracite/Anthracite grey	1 UN/Unit	8384235

Acciaio e Legno/Steel and Wood

M = 450
H = min. 1.780

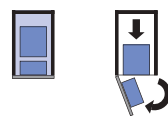
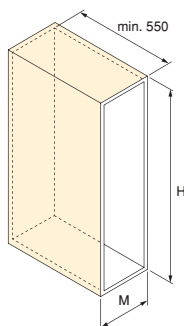
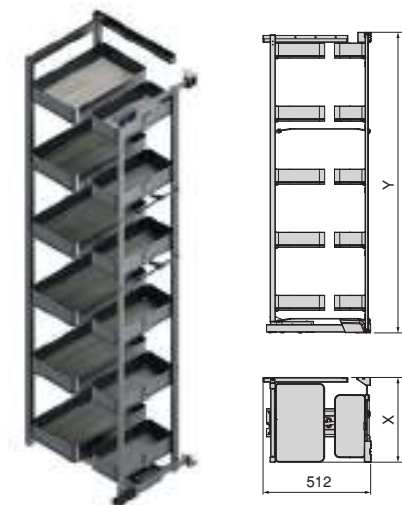

Consente il montaggio sia con apertura a sinistra che a destra.
Allows for both left-hand and right-hand opening.

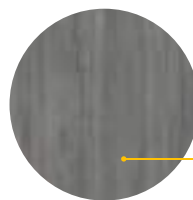

Base con lamiera melaminica.
Base with melamine sheet.

Regolazione in 5 dimensioni della porta.
5-dimensional door adjustment.

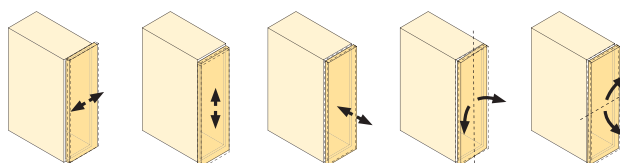

Colonna dispensa estraibile e girevole Harmony per mobili da cucina

Harmony swivel larder unit for kitchen furnitures



M	H	X	Y	n° cestini/ n° trays	Finitura/Finishing	Imballaggio/ Packaging	Cod.
400	1.430-1.730	350	1.427	5	Grigio antracite/Anthracite grey	1 UN/Unit	8383735
400	1.780-2.080	350	1.777	6	Grigio antracite/Anthracite grey	1 UN/Unit	8383835

Acciaio e Legno/Steel and Wood

M = 400
H = 1.780-2.080

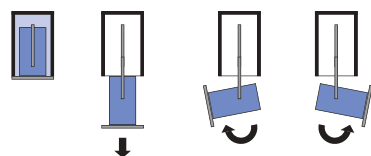
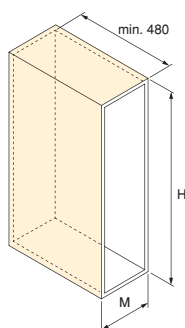
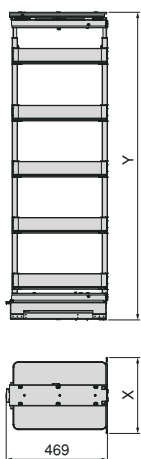

Consente un'estrazione totale e un'apertura sia verso sinistra che verso destra.
Allows for complete removal and opening to both the left and right.

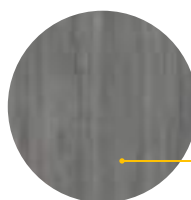

Base con lamiera melaminica.
Base with melamine sheet.

Regolazione in 5 dimensioni della porta.
5-dimensional door adjustment.

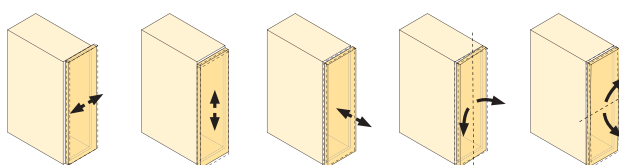

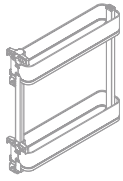

M150
H700
Cod. **8381935**

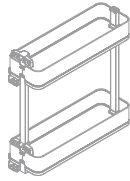

M200
H700
Cod. **8382135**

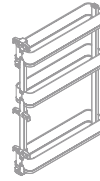

M150
H800
Cod. **8382035**

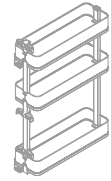

M200
H800
Cod. **8382235**

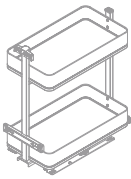

M300
H700
Cod. **8382335**

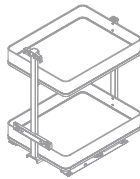

M400
H700
Cod. **8382535**

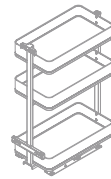

M300
H800
Cod. **8382435**



M400
H800
Cod. **8382635**

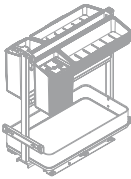

M300
H700
Cod. **8382735**

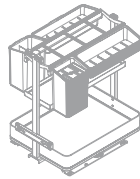

M400
H700
Cod. **8382835**

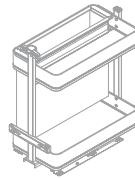

M300
H700
Cod. **8382935**

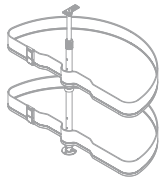
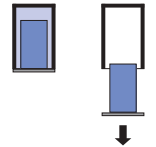

R358
Cod. **8383235**

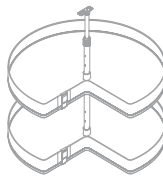

Ø708
Cod. **8383335**

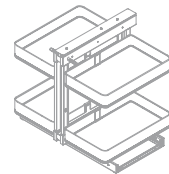

Cod. **8383435**

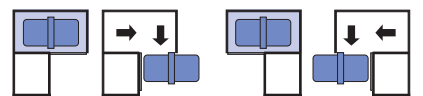
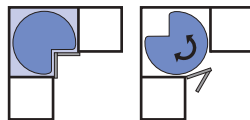
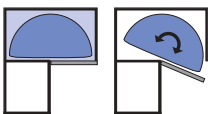

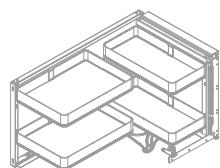

Destra/Right
Cod. **8383635**

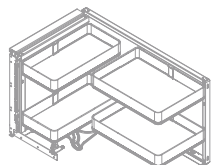

Sinistra/Left
Cod. **8383535**

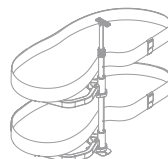

Destra/Right
Cod. **8383135**

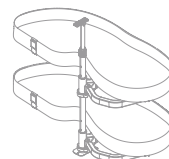

Sinistra/Left
Cod. **8383035**

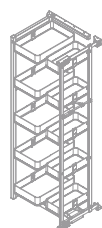
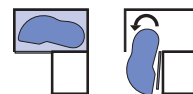
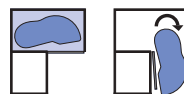
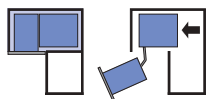
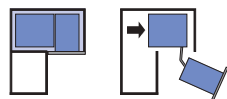

M450
H>1.480
Cod. **8383935**

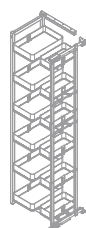

M450
H>1.780
Cod. **8384035**

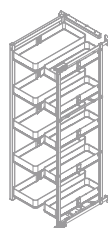

M600
H>1.480
Cod. **8384135**

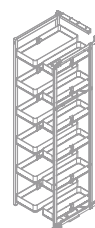

M600
H>1.780
Cod. **8384235**

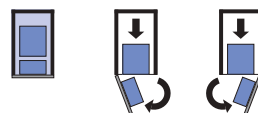

M400
H1.430-1.730
Cod. **8383735**

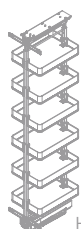

M400
H1.780-2.080
Cod. **8383835**

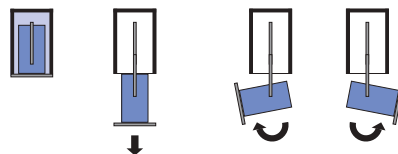

Vuoi saperne di più? Scansiona e scopri tutte le informazioni sugli accessori Harmony.
Want to know more? Scan and discover all the information about Harmony accessories.

emuca 
where creation begins

emuca 
where creation begins



Emuca S.R.L

Via Messico, 80 · 35127 · Padova (ITALIA)
T. +39 049 8702800

Emuca S.A.

Pl. El Oliveral - c/H, 4 · Apartado de correos 176
46394 · Riba-Roja del Túria · Valencia (ESPAÑA)
T. +34 96 166 70 19

Emuca Ltd.

Ground Floor Swift House, 18 Hoffmanns Way,
Chelmsford, Essex, England, CM1 1GU (UK)
T. +44 1268 530 674

Emuca S.A.R.L

Parc de l'Aubinière · 2 Avenue des Améthystes
44338 · Nantes Cedex 03 (FRANCE)
T. +33 2 49 88 07 35

Emuca Lda.

AV. da Liberdade n° 38, 4° · 1250-145
Lisboa (PORTUGAL)
T. +351 211 203 940

emuca.com

IT/EN - 09/2025 - Cod. 9000616



CERTIQUALITY
È MEMBRO DELLA
FEDERAZIONE CISQ